

SHERAZADE

Design Piero Lissoni

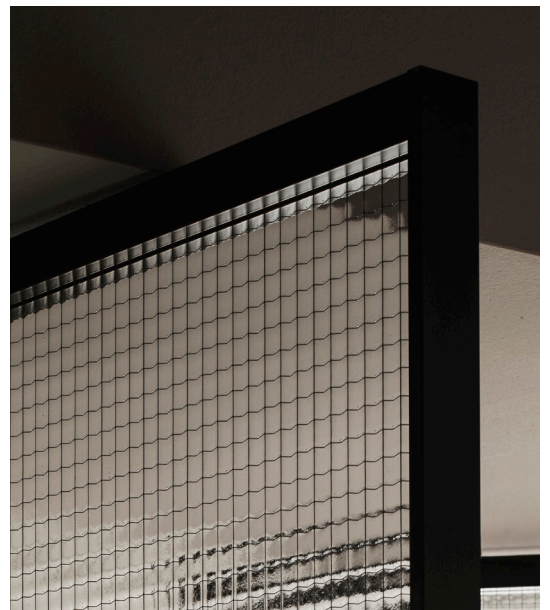

SHERAZADE SPIN PATCHWORK



SHERAZADE

Design Piero Lissoni

SHERAZADE SPIN PATCHWORK

Sherazade Spin Patchwork è un pannello con movimento rotatorio a bilico verticale, con cerniere a perno regolabili, che si presta a numerose soluzioni progettuali. L'anta, priva di battuta, ha sempre un'apertura bidirezionale ed è disponibile con perno centrale o decentrato. La versione con perno centrale ha una rotazione di 360 gradi.

Affiancando due o più pannelli, si possono configurare partizioni apribili parzialmente o totalmente. Il perfetto allineamento dei pannelli è garantito da un sistema magnetico (non è prevista una chiusura idraulica).

La superficie dell'anta è ripartita in quattro riquadri, in cui possono essere posizionati diversi tipi di cristalli temperati monolitici 6 mm o stratificati 3+3 mm.

Questi pannelli, tramite una guarnizione, vengono inseriti al centro di profili d'alluminio, forniti in cinque diverse finiture. I vetri, disponibili in una vastissima gamma di finiture, sono certificati secondo le normative di sicurezza ANSI Z97.1 e UNI EN 12150 (ad eccezione di 533. retinato).

Il corpo della cerniera superiore è alloggiato all'interno di un profilo d'alluminio da inserire a filo del controsoffitto e verniciare con la pitturazione dello stesso.

Sherazade Spin Patchwork is a panel with a vertical pivoting rotary movement, with adjustable pivot hinges, which lends itself to numerous design solutions.

The door WITH NO STOP always has a bidirectional opening and is available with a central or offset pivot. The version with central pivot has a rotation of 360 degrees. By placing two or more panels side by side, you can configure partially or totally openable partitions. The perfect alignment of the panels is guaranteed by a magnetic system. (there is no hydraulic closure)

The surface of the door is divided into four panels, into which different types of 6 mm monolithic or stratified 3 + 3 mm tempered glass can be positioned.

These panels are inserted through a gasket in the center of aluminum profiles, supplied in five different finishes.

The glass, available in a wide range of finishes, is certified according to the ANSI Z97.1 and UNI EN 12150 safety standards (except for 533. Retinato). Ceramic or wooden panels with different finishes and veneers are also available.

The body of the upper hinge is housed inside an aluminum profile, to be inserted flush with the false ceiling and painted as per the wall finish.

SHERAZADE

Design Piero Lissoni

SHERAZADE SPIN PATCHWORK

APERTURA PORTA SPIN / OPENING SPIN DOOR

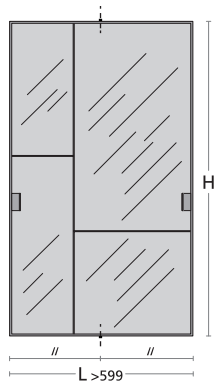

codice
code
SSP

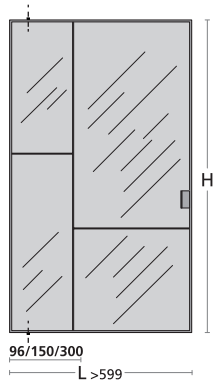
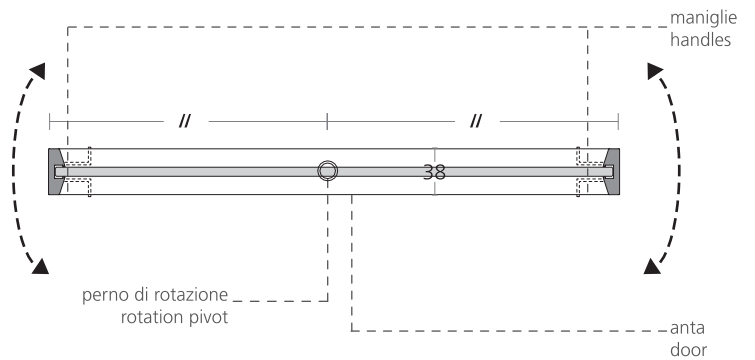

codice
code
SSP

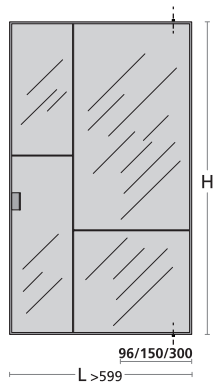
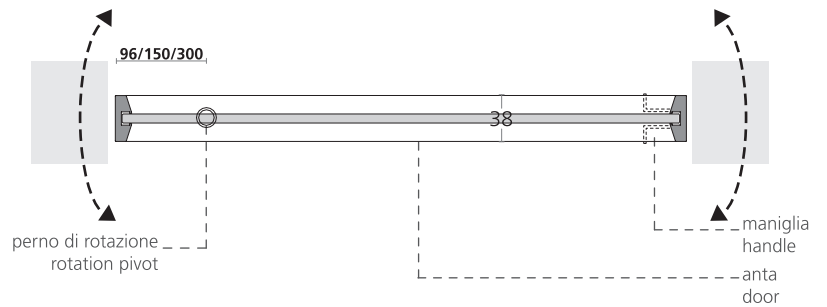

codice
code
SSP

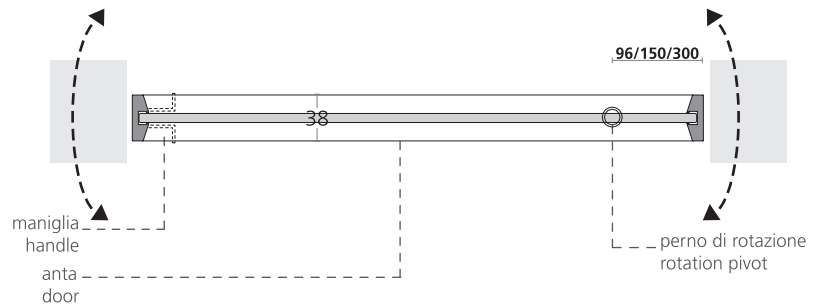

SHERAZADE

Design Piero Lissoni

SHERAZADE SPIN PATCHWORK

CONFIGURAZIONE PORTA SPIN / CONFIGURATION SPIN DOOR

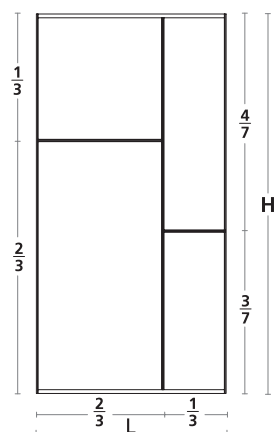

codice
code
SSP01

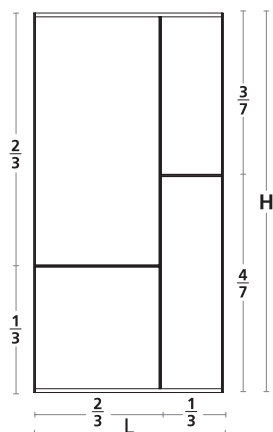

codice
code
SSP02

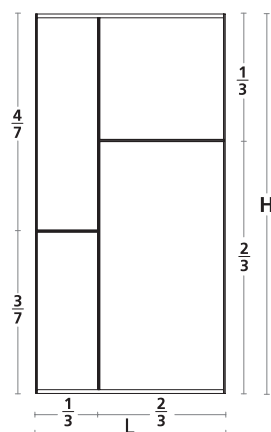

codice
code
SSP03

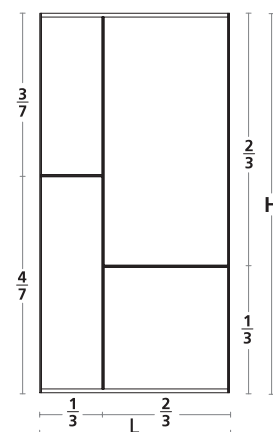

codice
code
SSP04

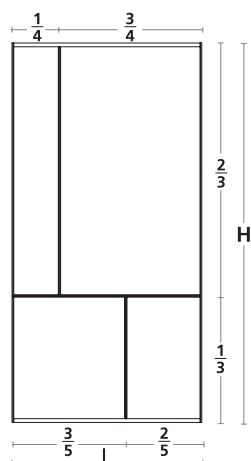

codice
code
SSP05

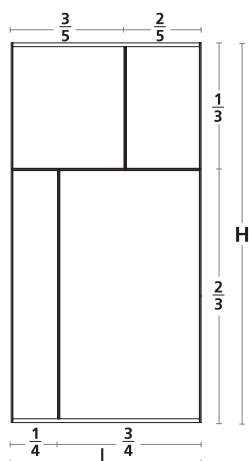

codice
code
SSP06

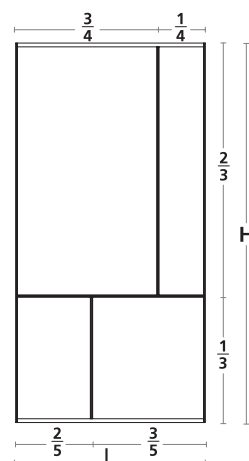

codice
code
SSP07

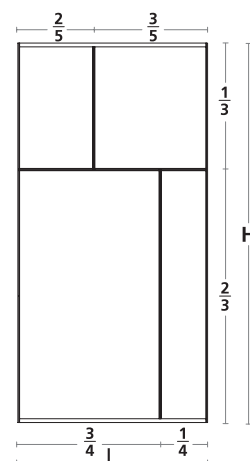

codice
code
SSP08

SHERAZADE

Design Piero Lissoni

SHERAZADE SPIN PATCHWORK

MANIGLIE PORTA SPIN / HANDLES SPIN DOOR

Maniglia senza supporto /
Handle without support

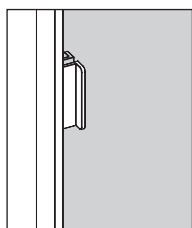

codice
code
MSSS